



DOP-107EV High color • Wide screen • User-friendly

DOP-107CV Delta Electronics, Inc.

No.18, Xinglong Rd., Taoyuan City
33068, Taiwan

Instruction Sheet

(1) General precautions

Thank you for purchasing this product. This instruction sheet provides information about the DOP-100 series HMI. Before using this product, please read through this instruction sheet carefully to ensure the correct use of the product. Please keep this sheet handy for quick reference whenever needed. Before finishing reading this sheet, please follow the instructions below:

- Install the product in an indoor location, which is free of vapor, corrosive and inflammable gas and liquids.
- Please refer to the wiring diagram when connecting the wires.
- Ensure your HMI is correctly grounded. The grounding method must comply with the national electrical standard (please refer to NFPA 70: National Electrical Code, 2005 Ed.).
- Do not disassemble the HMI or change the wiring when power is on.
- Do not touch the power supply when power is on, or it may cause electric shock.
- When the HMI displays a low power notification and requires a battery change, please contact your local distributor or Delta Customer Service Center for the replacement. Do not change the batteries by yourself.
- This product can be used with other industrial automation equipment. Please read through this sheet carefully and install the product according to the instructions to avoid danger.
- Cleaning method: please use a dry cloth to clean the product.
- This product must be used at an altitude below 2,000 m.
- If the equipment is used in a manner not specified by the manufacturer, the protection provided by the equipment may be impaired.
- For repair and maintenance, please contact Delta Electronics, Inc. Address: No.18, Xinglong Rd., Taoyuan City, Taiwan. TEL: +886-3-3626301.

If you have any inquiry during operation, please contact our local distributors or Delta sales representatives. The content of this instruction sheet may be revised without prior notice. Please consult our distributors or download the latest version at Delta's website (<http://www.delta.com.tw/ia>).

(2) Communication port pin assignment

DOP-107CV / DOP-107EV COM1

| COM Port | Pin | MODE1 |
|----------|-----|--------|
| | | RS-232 |
| | 1 | - |
| | 2 | RXD |
| | 3 | TXD |
| | 4 | - |
| | 5 | GND |
| | 6 | - |
| | 7 | RTS |
| | 8 | CTS |
| | 9 | - |

DOP-107CV / DOP-107EV COM2

| COM Port | Pin | MODE1 | | MODE2 | | MODE3 | |
|----------|-----|--------|--------|--------|--------|--------|--------|
| | | COM2 | COM3 | COM2 | COM3 | COM2 | COM3 |
| | | RS-232 | RS-485 | RS-485 | RS-485 | RS-232 | RS-422 |
| | 1 | - | - | D+ | - | - | TXD+ |
| | 2 | RXD | - | - | - | RXD | - |
| | 3 | TXD | - | - | - | TXD | - |
| | 4 | - | D+ | - | D+ | - | RXD+ |
| | 5 | GND | | GND | | GND | |
| | 6 | - | - | D- | - | - | TXD- |
| | 7 | RTS | - | - | - | RTS | - |
| | 8 | CTS | - | - | - | CTS | - |
| | 9 | - | D- | - | D- | - | RXD- |

Note: mark "-" means connection is not required.

(3) Description of each part

DOP-107CV / DOP-107EV (front view)

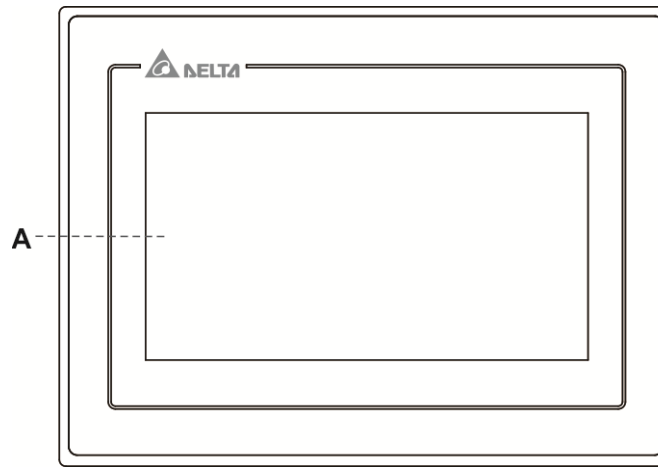

A Operation / display area

DOP-107CV / DOP-107EV (rear view)

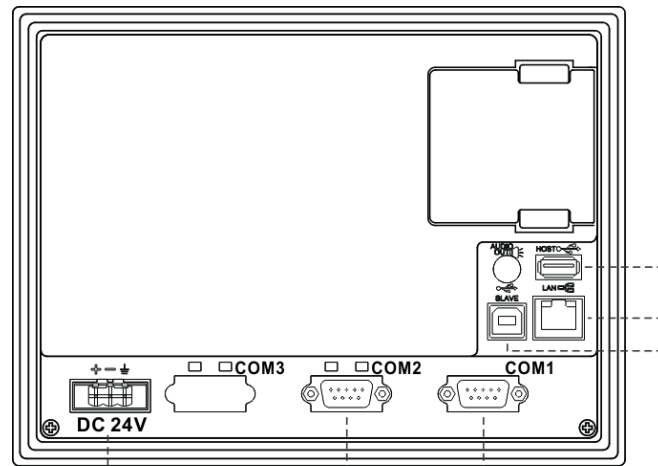

| | | | |
|---|--|---|-----------|
| A | Power input terminal (24AWG wire min.) | B | COM2/COM3 |
| C | COM1 | D | USB Host |
| E | Network port (LAN) Only for DOP-107EV | F | USB Slave |

(4) Mounting dimensions

DOP-107CV / DOP-107EV

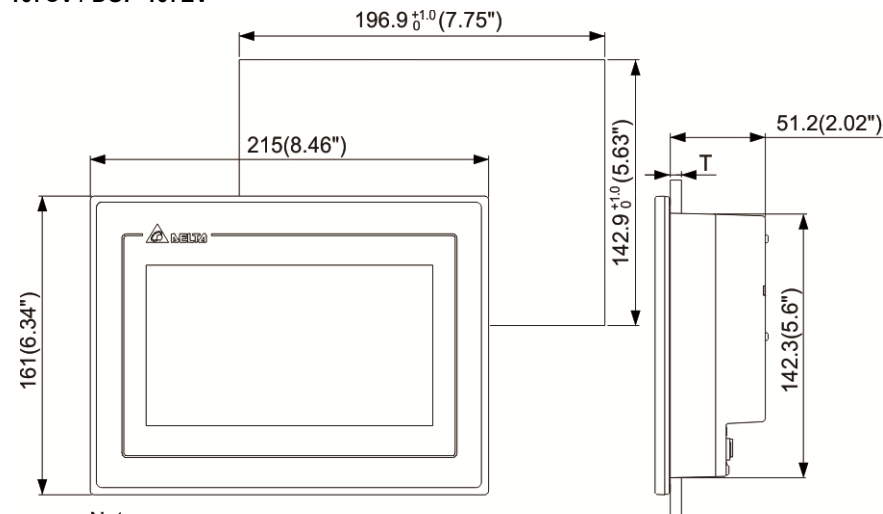

Note:
T=1.6 mm ~ 6 mm (0.063" ~ 0.24")

Unit: mm (inch)

Operation temperature: 0°C to 50°C (32°F to 122°F)
Storage temperature: -20°C to 60°C (-4°F to 140°F)

(5) Installation and wiring

Precautions:

- Incorrect installation may result in malfunction.
- To ensure the HMI is well ventilated, make sure there is sufficient space between the HMI and the adjacent objects or walls.
- This product should be used on a case / platform which conforms to enclosure Type 4X standard (for indoor use only).
- The maximum panel thickness for mounting must be no greater than 5 mm.
- Copper conductor only.

Installation steps:

Step 1:
Put the waterproof gasket into the HMI and then insert the HMI into the panel cutout.

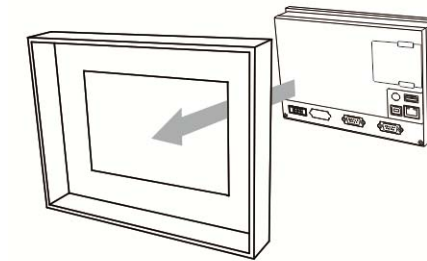

Step 2:
Place the fasteners into the slots and tighten the screws until reaching the panel cutouts.

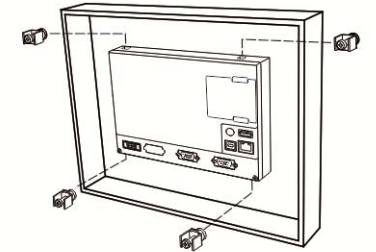

Step 3:
Tighten the screws with the torque less than 0.5 N-M / 0.7 N-M to avoid damage to the plastic case.
Torque for DOP-107CV / DOP-107EV:
6.17 lb-inch (0.7 N-M)

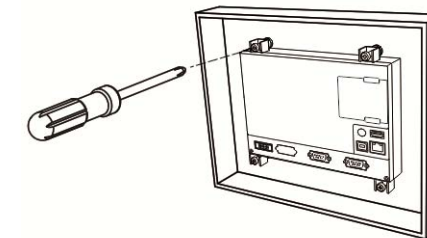

Step 4:
For heat dissipation, please keep a minimum clearance of 60 mm on the rear of the HMI.

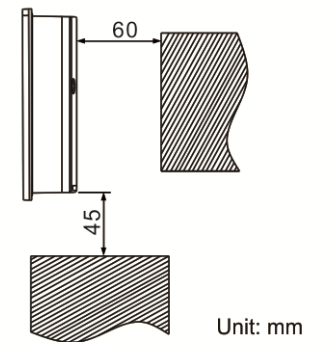

Unit: mm

Wiring:

| Type | Wire gauge (AWG) | Stripped length | Torque |
|----------|------------------|-----------------|---------------------|
| Solid | 24 - 12 | 7 - 8 mm | 5 kg-cm (4.3 lb-in) |
| Stranded | 24 - 12 | 7 - 8 mm | 5 kg-cm (4.3 lb-in) |



Please refer to the following diagram when wiring the power connector. The temperature rating of the cable must be greater than 75°C (167°F).

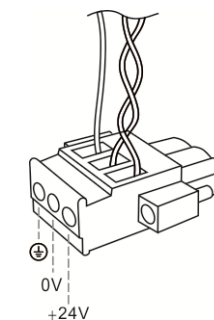

(6) Hardware specifications

| Model | | DOP-107CV | DOP-107EV |
|---------------------------------|---------------|--|---|
| Display | Panel type | 7" TFT LCD (65535 colors) | |
| | Resolution | 800 x 480 pixels | |
| | Backlight | LED Back Light (half-life under room temperature 25°C > 20,000 hours) ¹ | |
| | Display range | 154.08 x 85.92 mm | |
| | Brightness | 400 cd / m ² (Typ.) | |
| CPU | | ARM Cortex-A8 (800 MHz) | |
| Flash ROM | | 256 Mbytes | |
| RAM | | 256 Mbytes | |
| Touchscreen | | 4-wire resistive touchscreen > 10,000,000 operated | |
| Buzzer | | Multi-tone Frequency (2K – 4K Hz) / 80 dB | |
| Network interface | | N/A | 1 Port, 10 / 100 Mbps auto detection (built-in isolated circuit) ² |
| USB | | 1 USB Slave Ver. 2.0; 1 USB Host Ver. 2.0 | |
| SD | | N/A | |
| Serial communication port | COM1 | RS-232 (supporting flow control) ² | |
| | COM2 | RS-232 (supporting flow control) / RS-485 ² | |
| | COM3 | RS-422 / RS-485 ² | |
| Auxiliary function key | | N/A | |
| Calendar | | Built-in | |
| Cooling method | | Natural cooling | |
| Approvals | | CE / UL (please use shielding network cable and magnetic ring with the filter of 300 ohm / 100 MHz) | |
| Panel waterproof level | | IP65 / NEMA4 / UL TYPE 4X (indoor use only) | |
| Operation voltage ² | | DC +24V (-15% to +15%) (please use an isolated power supply) Supplied by Class 2 or SELV circuit (isolated from MAINS by double insulation) | |
| Leakage current | | 500 V _{AC} for 1 minute (between DC24V terminal and FG terminal) | |
| Power consumption ² | | 8.5 W (Max) ³ | 8.76 W (Max) ³ |
| Backup battery | | 3V lithium battery CR2032 × 1 | |
| Backup battery life | | About 3 years or more at 25°C (subject to operation temperature and condition) | |
| Operation temperature | | 0°C to 50°C (32°F to 122°F) | |
| Storage temperature | | -20°C to +60°C (-4°F to 140°F) | |
| Operating environment | | 10% to 90% RH [0°C - 40°C], 10% to 55% RH [41°C - 50°C]; pollution degree: 2 | |
| Vibration resistance | | Conforms to IEC61131-2: continuous vibration 5 Hz - 8.3 Hz with amplitude 3.5 mm; 8.3 Hz - 150 Hz with amplitude 1G | |
| Shock resistance | | Conforms to IEC60068-2-27: 11 ms, 15 G Peak, in X, Y, Z directions each for 6 times | |
| Dimension (W) x (H) x (D) mm | | 215 x 161 x 50 | |
| Mounting dimension (W) x (H) mm | | 196.9 x 142.9 | |
| Weight | | Approx. 970 g | |

Note:

- The half-life of the backlight is defined as the maximum luminance being reduced by 50% when the maximum drive current is supplied to the HMI. The life of LED backlight shown here is estimated at the room temperature of 25°C with ambient humidity.
- The withstand voltage of the isolated power circuit is 1500V peak for 1 minute.
- The HMI power consumption is the power consumed when the HMI is not connecting with other peripheral devices. To ensure normal operation of the HMI, the recommended capacity of the power supply is 1.5 to 2 times of the specified power consumption.
- Isolated power supply is recommended.
- For the DOPSoft programming software of the DOP-100 series and the user manual, you can download them at <http://www.delta.com.tw/ia>.
- DOP-100 series can be used with other industrial automation equipment. Please read through this sheet carefully and install the product according to the instructions to avoid danger.

DOP-107EV DOP-107CV

Yüksek Renk · Geniş Ekran · Kullanıcı Dostu HMI
Ürünleri
No.18, Xinglong Rd., Taoyuan City 33068, Taiwan

Bilgi Dokümanı

(1) Önsöz

Bu ürünü satın aldığınız için teşekkür ederiz. Bu bilgi dokümanı DOP-100 serileri için bilgiler sağlar. Ürünü kullanmadan önce, doğru şekilde kullanım sağlamak için lütfen dokümanı tamamen okuyunuz. Ayrıca daha sonra ihtiyaç duyulduğunda kullanabilmek için bu dokümanı iyi muhafaza ediniz. Bu dokümanı okumayı bitirdikten sonra lütfen aşağıda yazılı olan talimatları uygulayınız.

- Ürünün kurulumunu aşındırıcı, yanıcı gaz veya sıvılardan uzak, temiz ve kuru yerlere yapınız. Sadece iç mekânda kullanınız
- Tüm bağlantıların dokümanda belirtildiği gibi olduğuna emin olunuz.
- HMI toprak bağlantısının doğru olduğuna emin olunuz. Topraklama metodu uluslararası elektrik standardına uyumlu olmalıdır (NFPA 70: National Electrical Code, 2005 Ed).
- Ürün enerjili iken HMI'ı sökmezsiniz ve bağlantılara müdahale etmeyiniz.
- Çalışma sırasında güç kaynağına dokunmayınız. Aksi halde elektrik çarpması meydana gelebilir.
- HMI düşük pil uyarısı gösterirse ve pil değişimi gerekirse lütfen firmamız ile temasa geçiniz, kendiniz değiştirmeyiniz.
- DOP-100 serisi endüstriyel otomasyon ekipmanı olarak kullanılır. Lütfen bu dokümanı dikkatli okuyun ve tehlikeli durumları önlemek için ürünü belirtilen direktiflere uygun kurunuz.
- Temizleme metodu: Ürünü temizlemek için kuru bir bez kullanınız.
- Ürün 2000m altında bir rakımda kullanılmalıdır.
- Eğer ürün imalatçı tarafından belirtilmeyen bir şekilde kullanılıyorsa, ürün tarafından sağlanan koruma bozulabilir.
- Ürünle ilgili sorularınız için firmamız ile kontak kurabilirsiniz.

Ürünün kullanımı ile ilgili sorularınız için teknik servisimizle kontak kurabilirsiniz. Bu bilgi dokümanının içeriği herhangi bir bildirim gerek duyulmadan değiştirilebilir. Dokümanın son versiyonunu internetten indirebilirsiniz. <http://www.delta.com.tw/ia>.

(2) Haberleşme Pinleri

DOP-107CV / DOP-107EV COM1 port

| COM Port | Pin | MOD 1 | |
|----------|-----|--------|---|
| | | RS-232 | |
| | 1 | - | - |
| | 2 | RXD | - |
| | 3 | TXD | - |
| | 4 | - | - |
| | 5 | GND | - |
| | 6 | - | - |
| | 7 | RTS | - |
| | 8 | CTS | - |
| | 9 | - | - |

DOP-107CV / DOP-107EV COM2 port

| COM Port | Pin | MOD 1 | | MOD 2 | | MOD 3 | |
|----------|-----|--------|--------|--------|--------|--------|--------|
| | | COM2 | COM3 | COM2 | COM3 | COM2 | COM3 |
| | | RS-232 | RS-485 | RS-485 | RS-485 | RS-232 | RS-422 |
| | 1 | - | - | D+ | - | - | TXD+ |
| | 2 | RXD | - | - | - | RXD | - |
| | 3 | TXD | - | - | - | TXD | - |
| | 4 | - | D+ | - | D+ | - | RXD+ |
| | 5 | GND | - | GND | - | GND | - |
| | 6 | - | - | D- | - | - | TXD- |
| | 7 | RTS | - | - | - | RTS | - |
| | 8 | CTS | - | - | - | CTS | - |
| | 9 | - | D- | - | D- | - | RXD- |

Not: "-" olarak yazılan pinlere bağlantı yapılmaz.

(3) Parça Açıklamaları

DOP-107CV / DOP-107EV (Ön Görünüm)

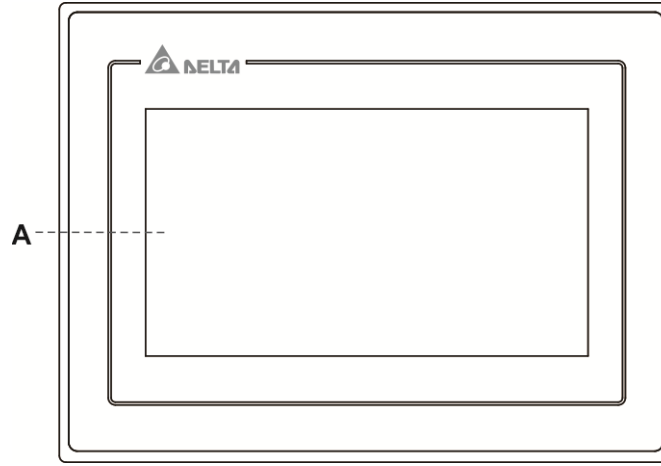

A Dokunmatik Ekran / Display

DOP-107CV / DOP-107EV (Arka Görünüm)

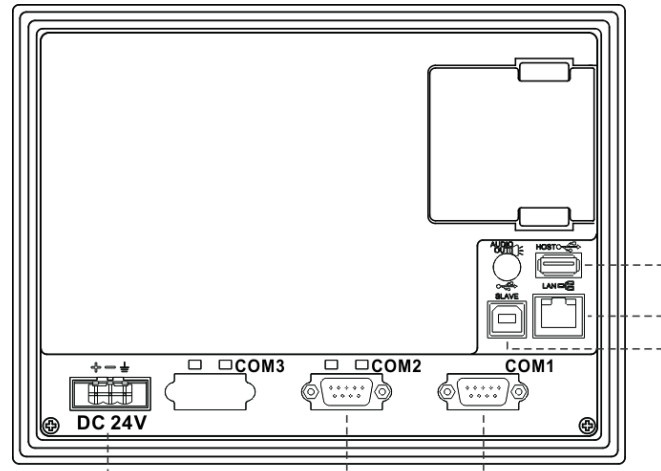

| A | B | C | D | E | F |
|-------------------------------------|-----------|------|----------|--------------------------------------|-----------|
| Güç Giriş Soketi (24AWG kablo min.) | COM2/COM3 | COM1 | USB Host | Network portu (LAN) Sadece DOP-107EV | USB Slave |

(4) Montaj Ölçüleri

DOP-107CV / DOP-107EV

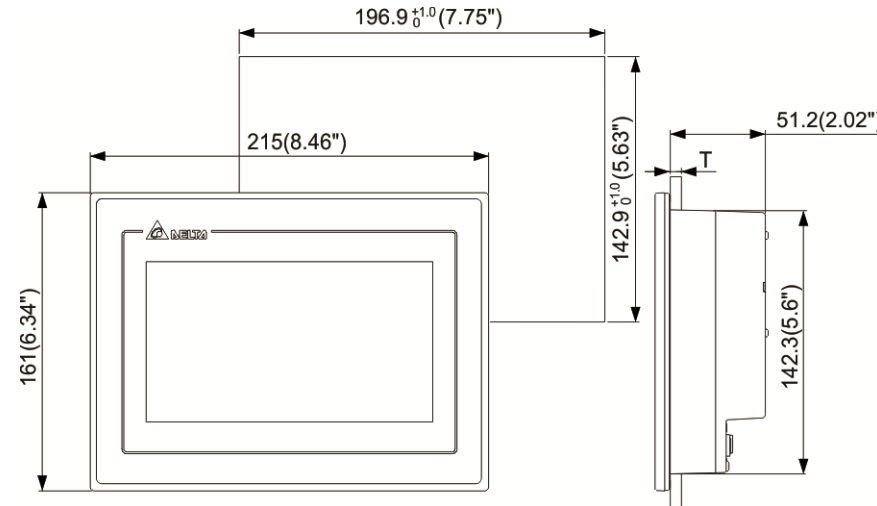

Note:
T=1.6 mm ~ 6 mm(0.063" ~ 0.24")

Çalışma Sıcaklığı: 0°C ~ 50°C (32°F ~ 122°F)

Depolama Sıcaklığı: -20°C ~ 60°C (-4°F ~ 140°F)

Birim: mm (inç)

(5) Montaj ve Kablolama

Önlemler:

- Yanlış kurulum arızalara sebep olabilir.
- HMI'in iyi havalandırıldığından emin olmak için, HMI ile yakın objeler veya duvarlar arasında yeterli boşluk olduğundan emin olun.
- Bu ürün, 4X standartına uygun bir kasa / platform (sadece kapalı alanda kullanım) üzerinde kullanılmalıdır.
- Montaj için kullanılan panelin kalınlığı 5 mm'den az olmalıdır.
- Sadece bakır kondansatör.

Montaj Adımları:

Adım 1:
HMI içine su geçirmez contanın takıldığına emin olunuz ve sonra pano boşluğuna yerleştiriniz.

Adım 2:
Montaj aparatlarını HMI'in yuvalarına yerleştiriniz ve sonra panoya değene kadar vidaları sıkınız.

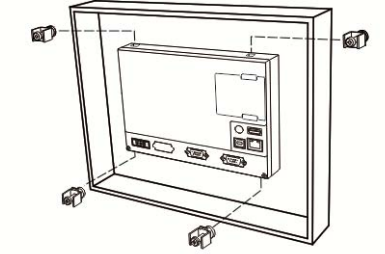
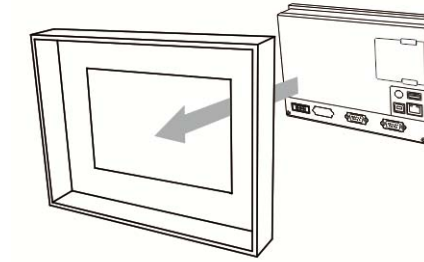

Adım 3:
Plastik kasaya zarar vermemek için vidayı 0.5 N-M'den fazla 0.7 N-M'den az tork ile sıkınız. DOP-107CV / DOP-107EV Tork: 6.17 lb-inç (0.7N-M)

Adım 4:
Isı dağılımı sağlanabilmesi için HMI arka paneli ile duvar, kurulum yüzeyi veya başka kontrol cihazı ile arasında en az 60 mm boşluk bırakınız.

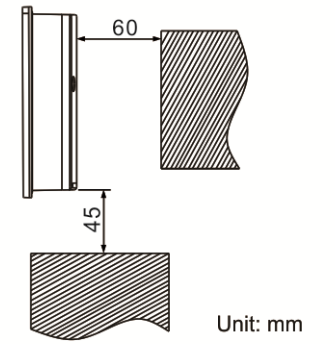
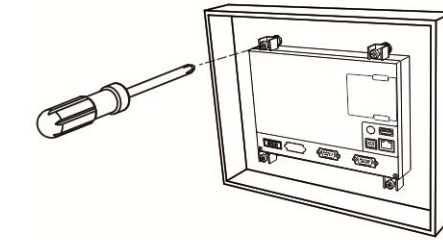

Unit: mm

Kablolama:

| Tip | Kablo Ölçüsü (AWG) | Soyma Uzunluğu | Tork |
|-------------|--------------------|----------------|---------------------|
| Tek Damarlı | 24 - 12 | 7 - 8 mm | 5 kg-cm (4.3 lb-in) |
| Çok Damarlı | 24 - 12 | 7 - 8 mm | 5 kg-cm (4.3 lb-in) |



Besleme konektörü bağlantısının aşağıdaki şekilde gösterildiği gibi yapıldığına emin olunuz. Kablo sıcaklık dayanım derecesi 75°C (167°F)'den yüksek olmalıdır.

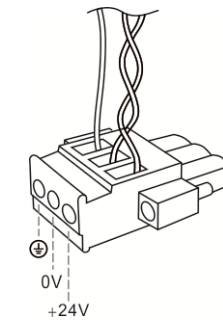

(6) Donanımsal Özellikler

| Model | | DOP-107CV | DOP-107EV |
|------------------------------|--------------|--|--|
| Ekran | Panel Tipi | 7" TFT LCD (65535 Renk) | |
| | Çözünürlük | 800 x 480 Piksel | |
| | Aydınlatma | LED Aydınlatma (Yarım ömürde 25°C'de 20,000 saatten az) *1 | |
| | Ekran Ölçüsü | 154.08 x 85.92 mm | |
| | Parlaklık | 400 cd / m ² (Tipik.) | |
| CPU | | ARM Cortex-A8 (800 MHz) | |
| Flash ROM | | 256 Mbytes | |
| RAM | | 256 Mbytes | |
| Dokunmatik | | 4 kablolu Rezistif Dokunmatik Ekran > 10,000,000 dokunma | |
| Buzzer | | Multi-tone Frequency (2K – 4K Hz) / 80 dB | |
| Ethernet Arabirimi | | Yok | 1 Port, 10 / 100 Mbps oto tanıma (Dâhili izolasyon devresi) ² |
| USB | | 1 USB Slave Ver. 2.0; 1 USB Host Ver. 2.0 | |
| SD | | Yok | |
| Seri Haberleşme Portu | COM1 | RS-232 (Flow Kontrol Destekler) ² | |
| | COM2 | RS-232 (Flow Kontrol Destekler) / RS-485 ² | |
| | COM3 | RS-422 / RS-485 ² | |
| Fonksiyon Tuşları | | Yok | |
| Takvim | | Dâhili | |
| Soğutma Metodu | | Doğal Soğutma | |
| Sertifikalar | | CE / UL (Lütfen ekranlı Ethernet kablosu ve 300 ohm/100 MHz filtre ile manyetik halka kullanınız) | |
| Su Geçirmezlik Seviyesi | | IP65 / NEMA4 / UL Tip 4X (Bina içi kullanım içindir) | |
| Çalışma Voltajı ² | | DC +24V (-15% ~ +15%) (Lütfen dâhili filtreli güç kaynağı kullanınız.) SELV ile beslenir. (Şebeke hattından çift yalıtım ile izole edilmiştir) | |
| Kaçak Akım Dayanımı | | 1 dakika için 500 V _{AC} (DC24V terminal ve FG terminalleri arası) | |
| Güç Tüketimi ² | | 8.5 W (Maks) *3 | 8.76 W (Maks) *3 |
| Yedekleme Pili | | 3V lityum pil CR2032 × 1 | |
| Yedekleme Pil Ömrü | | Normal koşullarda 25°C'de 3 yıl veya daha fazla. | |
| Çalışma Sıcaklığı | | 0°C ~ 50°C (32°F ~ 122°F) | |
| Depolama Sıcaklığı | | -20°C ~ +60°C (-4°F ~ 140°F) | |
| Çalışma Ortamı | | 10% ~ 90% RH [0°C - 40°C], 10% ~ 55% RH [41°C - 50°C]; Kirlenme Derecesi: 2 | |
| Titreşim Direnci | | IEC61131-2 ile uyumlu; Sürekli: 5 Hz ~ 8.3 Hz 3.5 mm, 8.3 Hz ~ 150 Hz 1 G | |
| Şok Direnci | | IEC60068-2-27 ile uyumlu: 11 ms, 15 G Pik, X, Y, Z yönünde 6 kere | |
| Ölçüleri (G) x (Y) x (D) mm | | 215 x 161 x 50 | |
| Kesim Ölçüleri (G) x (Y) mm | | 196.9 x 142.9 | |
| Ağırlık | | Yaklaşık. 970 g | |

Not:

- Arka ışık yarı-ömrü maksimum besleme akımı HMI'ya uygulandığında orijinal parlaklığın %50 oranında azaltılmış olması olarak tanımlanır. Burada gösterilen LED aydınlatma ömrü 25°C normal sıcaklık ve nem koşullarında tahmini bir değerdir.
- İzoleli güç devresi dayanma voltajı 1 dakika için 1500 V pik.
- HMI güç tüketimi herhangi bir cihaza bağlı değil iken tükettiği güçtür. Normal çalışma için tavsiye edilen güç kaynağı tüketilen gücün 1.5 ~ 2 katıdır.
- İzoleli güç kaynağı kullanılması tavsiye edilir.
- DOP-100 serisi ürünlerin program editörü olan DOPSoft programı ve kullanıcı manuel'i web sayfamızdan indirilebilirsiniz. http://www.delta.com.tw/ia_
- DOP-100 serisi endüstriyel otomasyon donanımı olarak kullanılabilir. Tehlikeleri önlemek için bu bilgi dokümanını dikkatlice okuyun ve belirtilen direktiflere göre kurulumu gerçekleştirin.

Delta Greentech Elektronik San. Ltd. Şti.

Şerifali Mahallesi, Hendem Caddesi, Kule Sokak, No:16,
A Blok Ümraniye / İstanbul, Türkiye
TEL: +90 216 499 99 10 Fax: + 90 216 499 80 70
Website: www.delta-turkey.com

Factory information:

Delta Electronics, Inc.

Taiwan

31-1 Xingbang Road,

Gulshan Industrial Zone,

Tsuyuan County 33370,

Taiwan

TEL: 886-3-362-6301

FAX: 886-3-362-7267

China

1686 Jiangxing East Road,

Wujiang Economic Development Zone

Wujiang City, Jiang Su Province,

People's Republic of China (Post code: 215200)

TEL: 86-512-6340-3006

FAX: 86-769-6340-7290



DOP-107EV DOP-107CV

高彩・寬螢幕・友善人機介面
Delta Electronics Inc,
No.18, Xinglong Rd., Taoyuan City
33068, Taiwan

安裝說明

(1) 一般注意事項

感謝您使用本產品。本人機介面安裝說明書提供 DOP-100 系列人機介面的相關資訊。在使用之前，請您仔細詳讀本說明書以確保正確使用本產品。此外，請妥善將本說明書放置在明顯的地點以便隨時查閱。在您尚未讀完本說明書前，請務必遵守下列事項：

- 安裝的環境必須為沒有水氣、腐蝕性氣體及可燃性氣體之室內安裝環境 (indoor use only)。
- 接線時，請依接線圖說明施工。
- 接地工程必須確實實施，接地時須遵照國家現行相關電工法規之規定施行 (請參考 NFPA 70: National Electrical Code, 2005 Ed.)。
- 在通電時，請勿拆解人機介面或更改配線。
- 在通電運作時，請勿接觸電源處，以免觸電。
- 當程式顯示電量不足時須更換電池並請聯絡台達電子或當地經銷商，請勿自行更換。
- 此產品適用於工業自動化設備，請詳細閱讀此說明，並依指示安裝避免產生危險。
- 清潔方式：請以乾布擦拭清潔。
- 適用之海拔高度為 2000 米以下。
- 若使用本設備時未遵循製造商所訂定之規格，將導致本設備所提供的保護功能受損。
- 維修請聯絡：台達電子工業股份有限公司，台灣桃園市興隆路 18 號，TEL: 03-3626301。

如果您在使用上仍有問題，請洽詢經銷商或者本公司客服中心。由於產品精益求精，當內容規格有所修正時，請洽詢代理商或至台達網站(<http://www.delta.com.tw/ia>)下載最新版本。

(2) 通訊腳位定義

DOP-107CV/DOP-107EV COM1 定義

| COM Port 示意圖 | 腳位 | MODE1 |
|--------------|----|--------|
| | 1 | RS-232 |
| | 2 | - |
| | 3 | RXD |
| | 4 | TXD |
| | 5 | - |
| | 6 | GND |
| | 7 | - |
| | 8 | RTS |
| | 9 | CTS |

DOP-107CV/DOP-107EV COM2 定義

| COM Port 示意圖 | 腳位 | MODE1 | | MODE2 | | MODE3 | |
|--------------|----|--------|--------|--------|--------|--------|--------|
| | | COM2 | COM3 | COM2 | COM3 | COM2 | COM3 |
| | | RS-232 | RS-485 | RS-485 | RS-485 | RS-232 | RS-422 |
| | 1 | - | - | D+ | - | - | TXD+ |
| | 2 | RXD | - | - | - | RXD | - |
| | 3 | TXD | - | - | - | TXD | - |
| | 4 | - | D+ | - | D+ | - | RXD+ |
| | 5 | GND | - | GND | - | GND | - |
| | 6 | - | - | D- | - | - | TXD- |
| | 7 | RTS | - | - | - | RTS | - |
| | 8 | CTS | - | - | - | CTS | - |
| | 9 | - | D- | - | D- | - | RXD- |

註：未標示處不需連接

(3) 各部位說明

DOP-107CV / DOP-107EV (正面)

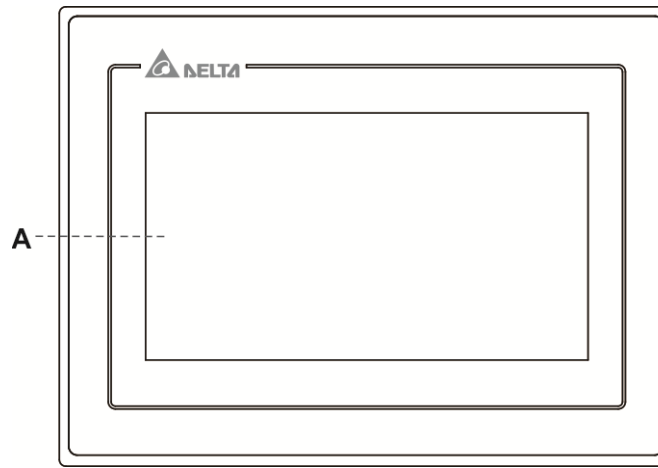

A 操作 / 顯示區域

DOP-107CV / DOP-107EV (背面)

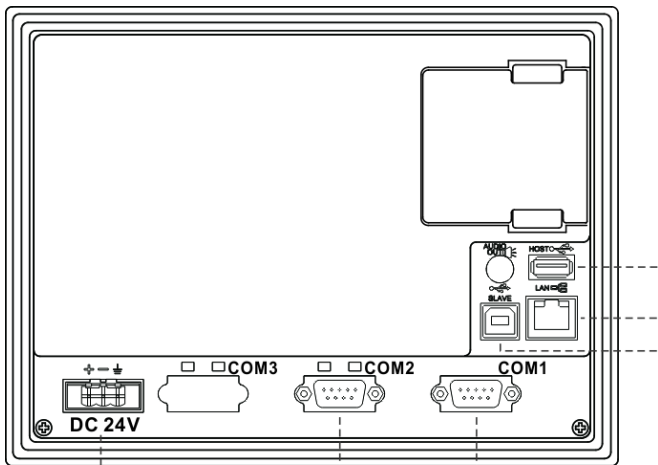

| | A | B | C | D | E | F |
|---|---------------------------------|---|-----------|---|----------|---|
| A | 電源輸入端子 (24AWG wire min.) | B | COM2/COM3 | D | USB Host | F |
| C | COM1 | | | | | |
| E | 網路埠 (LAN) Only for DOP-107EV | | | | | |

(4) 開孔尺寸

DOP-107CV / DOP-107EV

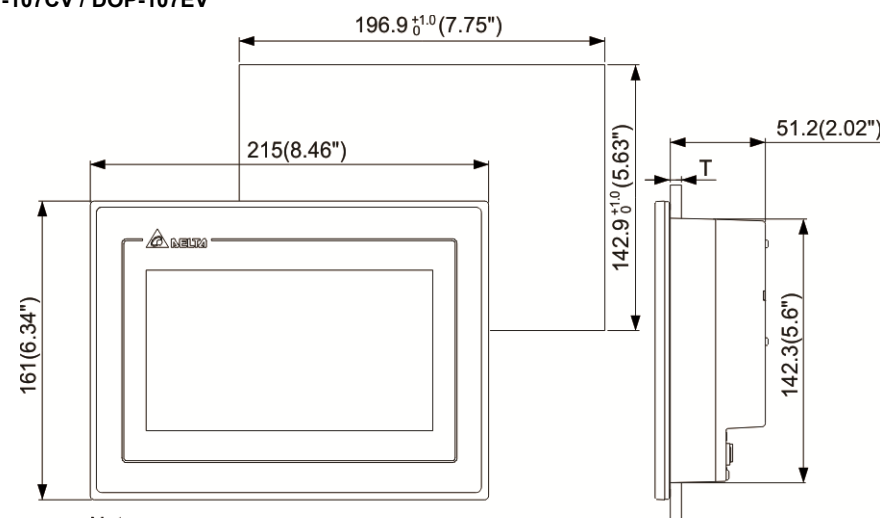

Note:
T=1.6 mm ~ 6 mm(0.063" ~ 0.24")

單位：mm (inch)

操作溫度為 0°C ~ 50°C；儲存溫度為-20°C ~ +60°C

(5) 安裝方向與配線

注意事項：

- 安裝方向必須依規定，否則會造成故障。
- 為了使冷卻循環效果良好，安裝人機介面時，其上下左右與相鄰的物品和擋板(牆)必須保持足夠的空間，否則會造成散熱不良。
- 使用於 Type 4X 室內用等級之外殼平面。
- 安裝面板最大板厚請勿超過 5 mm。
- 請用銅製導線。

安裝示意圖：

步驟一：

請確實將防水墊圈裝入，然後再安裝人機介面。

步驟二：

請確實將固定片螺絲組裝入內，然後下方鉤住前蓋螺絲頭頂住控制箱內側。

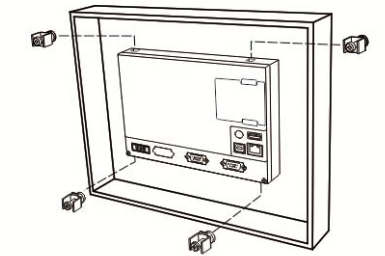
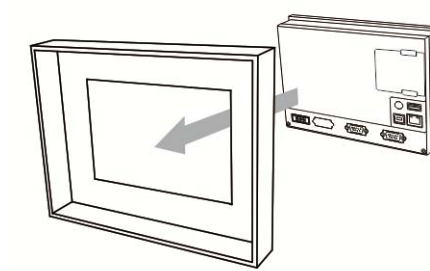

步驟三：

請以 0.5 N-M / 0.7 N-M 扭力鎖緊，切記不可超過此扭力，否則將造成塑膠外殼的損壞。

DOP-107CV/DOP-107EV 扭力：6.17 lb-inch (0.7N-M)

步驟四：

安裝時，人機後方請預留 60 mm 散熱空間。

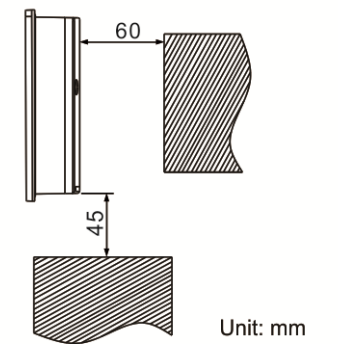
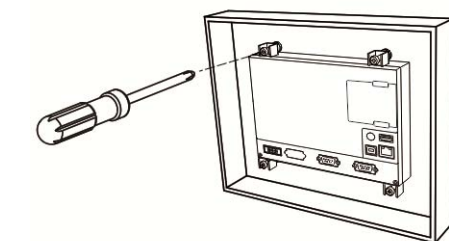

Unit: mm

配線：

| 種類 | 電源配線(AWG) | 剝線長度 | 扭力 |
|-----|-----------|----------|---------------------|
| 單芯線 | 24 ~ 12 | 7 ~ 8 mm | 5 kg-cm (4.3 lb-in) |
| 多芯線 | 24 ~ 12 | 7 ~ 8 mm | 5 kg-cm (4.3 lb-in) |



請參考下圖電源接頭端子進行配線，安裝與配線要求至少使用耐溫等級 75°C 以上：

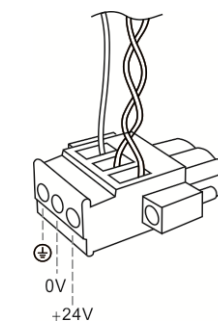

(6) 硬體規格

| 型號 | | DOP-107CV | DOP-107EV |
|--------------------------|------|---|--|
| 顯示器 | 面板種類 | 7" TFT LCD (65535 色) | |
| | 解析度 | 800 x 480 pixels | |
| | 背光燈 | LED Back Light (常溫 25°C 下半衰期 > 2 萬小時) ¹ | |
| | 顯示範圍 | 154.08 x 85.92 mm | |
| | 亮度 | 400 cd / m ² (Typ.) | |
| 中央處理器 | | ARM Cortex-A8 (800MHz) | |
| Flash ROM | | 256 Mbytes | |
| RAM | | 256 Mbytes | |
| 觸控面板 | | 四線電阻式 > 10,000,000 operated | |
| 蜂鳴器 | | Multi-Tone Frequency (2K ~ 4K Hz) / 80dB | |
| 網路介面 | | N/A | 1 Port, 10/100 Mbps 自動偵測 (內建隔離電路) ² |
| USB | | 1 USB Slave Ver 2.0 ; 1 USB Host Ver 2.0 | |
| SD | | N/A | |
| 串列通訊埠 | COM1 | RS-232 (支援流量控制) ² | |
| | COM2 | RS-232 (支援流量控制) / RS-485 ² | |
| | COM3 | RS-422 / RS-485 ² | |
| 輔助鍵 | | N/A | |
| 萬年曆 | | 內建 | |
| 冷卻方式 | | 自然冷卻 | |
| 安規認證 | | CE / UL (請使用 shielding 網路線與使用磁環 300 ohm / 100 MHz 濾波) | |
| 面板防水等級 | | IP65 / NEMA4 / UL TYPE 4X (僅限用於室內環境) | |
| 工作電壓 ² | | DC +24V (-15% ~ +15%) (請使用隔離式電源供應器) Supplied by Class 2 or SELV circuit (isolated from MAINS by double insulation) | |
| 絕緣耐力 | | DC24V 端子與 FG 端子間：AC500V, 1 分鐘 | |
| 消耗功率 ² | | 8.5 W (Max) ³ | 8.76 W (Max) ³ |
| 記憶體備份電池 | | 3V 鋰電池 CR2032 × 1 | |
| 備份電池壽命 | | 依使用環境溫度及使用條件而不同·常溫 25°C 下壽命約三年以上 | |
| 操作溫度 | | 0°C ~ 50°C | |
| 儲存溫度 | | -20°C ~ +60°C | |
| 工作環境 | | 10% ~ 90% RH [0 ~ 40°C] · 10% ~ 55% RH [41 ~ 50°C] · 污染等級 2 | |
| 耐震動 | | IEC61131-2 規定連續震動 5 Hz ~ 8.3 Hz 3.5 mm, 8.3 Hz ~ 150 Hz 1G | |
| 耐衝擊 | | IEC60068-2-27 規定耐衝擊 11 ms, 15G Peak, X, Y, Z 方向各 6 次 | |
| 尺寸 (W) x (H) x (D) mm | | 215 x 161 x 50 | |
| 開孔尺寸 (W) x (H) mm | | 196.9 x 142.9 | |
| 重量 | | 約 970 g | |

註：

- 背光模組半衰期的定義：最大驅動電流下，背光亮度衰退到最大亮度的一半時，即為半衰期。所標示之壽命時間為 25°C 常溫常濕工作環境下之預估值。
- 隔離電路耐受規格：可承受 1 分鐘 1500 V 高壓突波。
- 消耗功率為無外接週邊設備時，人機本體所消耗的功率。建議選用的電源供應器容量為標示消耗功率之 1.5 ~ 2 倍，以確保人機工作正常。
- 建議使用隔離式電源供應器。
- DOP-100 系列編輯軟體 DOPSoft 系列及其使用操作手冊，可由台達網站下載取得，網址為 <http://www.delta.com.tw/ia>。
- DOP-100 系列適用於工業自動化設備，請詳細閱讀此說明，並依指示安裝避免產生危險。



DOP-107EV DOP-107CV

高彩·宽屏幕·友好人机界面
Delta Electronics Inc,
No.18, Xinglong Rd., Taoyuan City
33068, Taiwan

安装说明

(1) 一般注意事项

感谢您使用本产品，本人机界面安装说明书提供 DOP-100 系列人机界面的相关信息。在使用之前，请您仔细阅读本说明书以确保正确使用本产品。此外，请妥善将本说明书放置在明显的地点以便随时查阅。在您尚未读完本说明书前，请务必遵守下列事项：

- 安装的环境必须为没有水气、腐蚀性气体及可燃性气体的室内安装环境 (indoor use only)。
- 接线时，请依接线图说明施工。
- 接地工程必须确实实施，接地时须遵照国家现行相关电工法规的规定施行 (请参考 NFPA 70: National Electrical Code, 2005 Ed.)。
- 在通电时，请勿拆解人机界面或更改配线。
- 在通电运作时，请勿接触电源处，以免触电。
- 当程序显示电量不足时须更换电池并请联系台达电子或当地经销商，请勿自行更换。
- 此产品适用于工业自动化设备，请仔细阅读此说明，并依指示安装避免产生危险。
- 清洁方式：请用干布擦拭清洁。
- 适用于海拔高度为 2000 米以下。
- 若使用本设备时未遵循制造商所订定的规格，将导致本设备所提供的保护功能受损。
- 维修请联系：台达电子工业股份有限公司，台湾桃园市兴隆路 18 号，TEL: 03-3626301。

如果您在使用上仍有问题，请咨询经销商或者本公司客服中心。由于产品精益求精，当内容规格有所修正时，请咨询代理商或至台达网站(<http://www.delta.com.tw/ia>)下载最新版本。

(2) 通讯 pin 脚定义

DOP-107CV/DOP-107EV COM1 定义

| COM Port 示意图 | 脚位 | MODE1 |
|--------------|----|-------|
| | 1 | - |
| | 2 | RXD |
| | 3 | TXD |
| | 4 | - |
| | 5 | GND |
| | 6 | - |
| | 7 | RTS |
| | 8 | CTS |
| | 9 | - |

DOP-107CV/DOP-107EV COM2 定义

| COM Port 示意图 | 脚位 | MODE1 | | MODE2 | | MODE3 | |
|--------------|----|--------|--------|--------|--------|--------|--------|
| | | COM2 | COM3 | COM2 | COM3 | COM2 | COM3 |
| | | RS-232 | RS-485 | RS-485 | RS-485 | RS-232 | RS-422 |
| | 1 | - | - | D+ | - | - | TXD+ |
| | 2 | RXD | - | - | - | RXD | - |
| | 3 | TXD | - | - | - | TXD | - |
| | 4 | - | D+ | - | D+ | - | RXD+ |
| | 5 | GND | - | GND | - | GND | - |
| | 6 | - | - | D- | - | - | TXD- |
| | 7 | RTS | - | - | - | RTS | - |
| | 8 | CTS | - | - | - | CTS | - |
| 9 | - | D- | - | D- | - | RXD- | |

注：未标示处不需连接

(3) 各部位说明

DOP-107CV / DOP-107EV (正面)

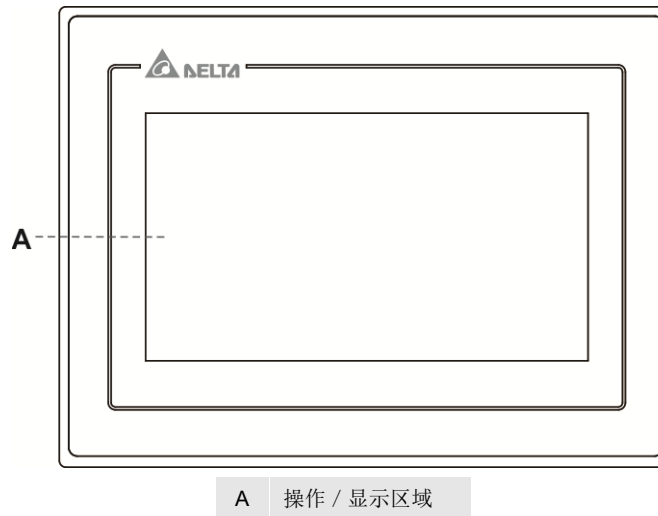

A 操作 / 显示区域

DOP-107CV / DOP-107EV (背面)

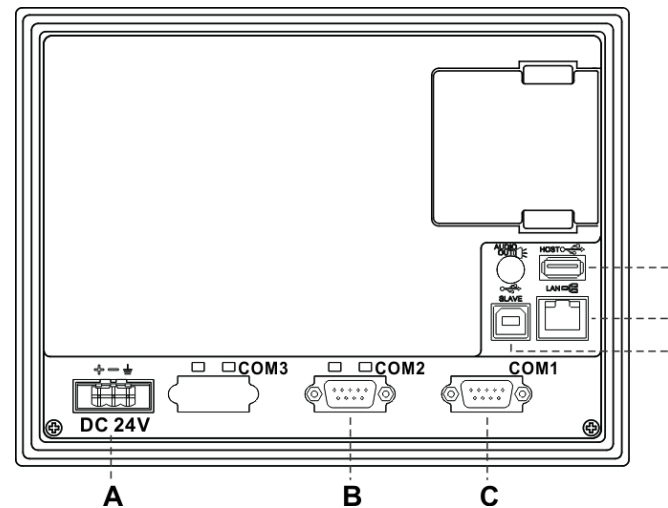

| | | | |
|---|----------------------------------|---|-------------|
| A | 电源输入端子 (24AWG wire min.) | B | COM2 / COM3 |
| C | COM1 | D | USB Host |
| E | 网络端口 (LAN) Only for DOP-107EV | F | USB Slave |

(4) 开孔尺寸

DOP-107CV / DOP-107EV

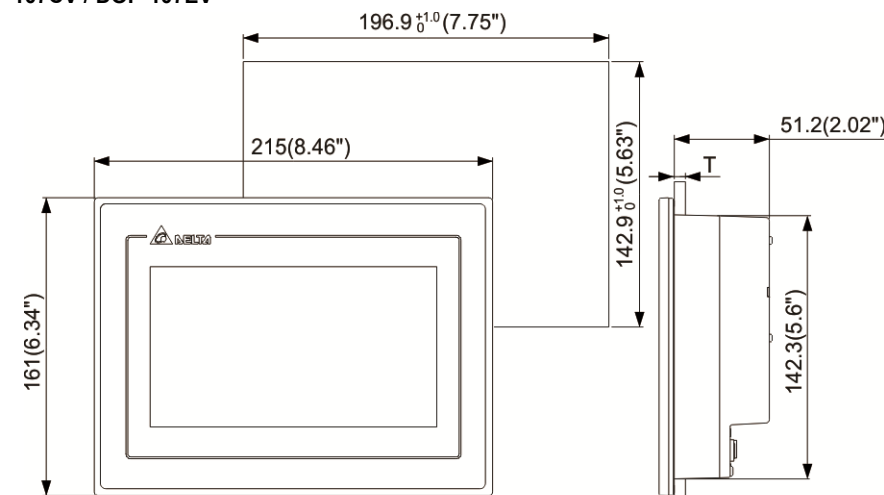

Note:
T=1.6 mm ~ 6 mm(0.063" ~ 0.24")

单位: mm (inch)

操作温度为 0°C ~ 50°C; 储存温度为 -20°C ~ +60°C

(5) 安装方向与配线

注意事项:

- 安装方向必须依规定，否则会造成故障。
- 为了使冷却循环效果良好，安装人机界面时，其上下左右与相邻的物品和挡板(墙)必须保持足够的空间，否则会造成散热不良。
- 使用于 Type 4X 室内用等级的外壳平面。
- 安装面板最大板厚请勿超过 5 mm。
- 请用铜制导线。

安装示意图:

步骤一:
请确实将防水垫圈装入，然后再安装人机界面。

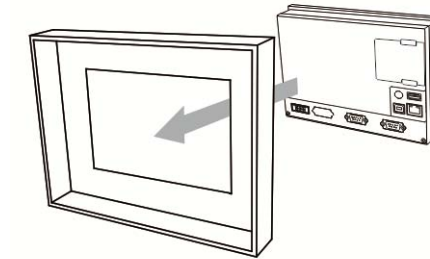

步骤二:
请确实将固定片螺丝组装入内，然后下方钩住前盖螺丝头顶住控制箱内侧。

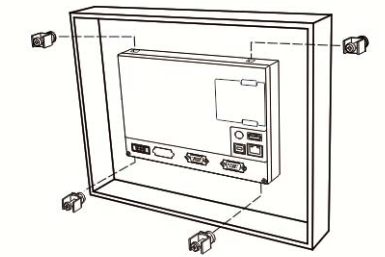

步骤三:
请以 0.5 N-M / 0.7 N-M 扭力锁紧，切记不可超过此扭力，否则将造成塑胶外壳的损坏。
DOP-107CV/DOP-107EV 扭力: 6.17 lb-inch (0.7N-M)

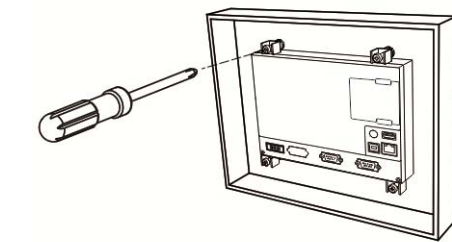

步骤四:
安装时，人机后方请预留 60 mm 散热空间。

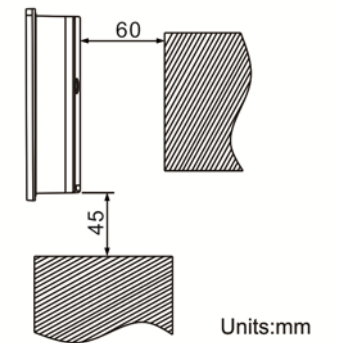

配线:

| 种类 | 电源配线(AWG) | 剥线长度 | 扭力 |
|-----|-----------|----------|---------------------|
| 单芯线 | 24 ~ 12 | 7 ~ 8 mm | 5 kg-cm (4.3 lb-in) |
| 多芯线 | 24 ~ 12 | 7 ~ 8 mm | 5 kg-cm (4.3 lb-in) |



请参考下图电源接头端子进行配线，安装与配线要求至少使用耐温等级 75°C 以上:

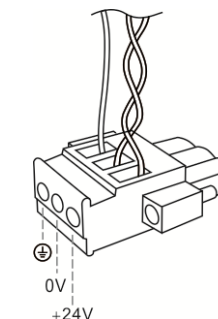

(6) 硬件规格

| 型号 | | DOP-107CV | DOP-107EV |
|--------------------------|------|---|--|
| 显示器 | 面板种类 | 7" TFT LCD (65535 色) | |
| | 解析度 | 800 x 480 pixels | |
| | 背光灯 | LED Back Light (常温 25°C 下半衰期 > 2 万小时) ¹ | |
| | 显示范围 | 154.08 x 85.92 mm | |
| | 亮度 | 400 cd / m ² (Typ.) | |
| 中央处理器 | | ARM Cortex-A8 (800MHz) | |
| Flash ROM | | 256 Mbytes | |
| RAM | | 256 Mbytes | |
| 触摸屏 | | 四线电阻式 > 10,000,000 operated | |
| 蜂鸣器 | | Multi-Tone Frequency (2K ~ 4K Hz) / 80dB | |
| 网络界面 | | N/A | 1 Port, 10/100 Mbps 自动检测 (内建隔离电路) ² |
| USB | | 1 USB Slave Ver 2.0; 1 USB Host Ver 2.0 | |
| SD | | N/A | |
| 串行通讯端口 | COM1 | RS-232 (支持流量控制) ² | |
| | COM2 | RS-232 (支持流量控制) / RS-485 ² | |
| | COM3 | RS-422 / RS-485 ² | |
| 辅助键 | | N/A | |
| 实时时钟 | | 内建 | |
| 冷却方式 | | 自然冷却 | |
| 安规认证 | | CE / UL (请使用 shielding 网络线与使用磁环 300 ohm / 100 MHz 滤波) | |
| 面板防水等级 | | IP65 / NEMA4 / UL TYPE 4X (仅限于室内环境) | |
| 工作电压 ² | | DC +24V (-15% ~ +15%) (请使用隔离式电源供应器) Supplied by Class 2 or SELV circuit (isolated from MAINS by double insulation) | |
| 绝缘耐力 | | DC24V 端子与 FG 端子间: AC500V, 1 分钟 | |
| 消耗功率 ² | | 8.5 W (Max) ³ | 8.76 W (Max) ³ |
| 存储器备份电池 | | 3V 锂电池 CR2032 x 1 | |
| 备份电池寿命 | | 依使用环境温度及使用条件而不同, 常温 25°C 下寿命约三年以上 | |
| 操作温度 | | 0°C ~ 50°C | |
| 储存温度 | | -20°C ~ +60°C | |
| 工作环境 | | 10% ~ 90% RH [0 ~ 40°C], 10% ~ 55% RH [41 ~ 50°C], 污染等级 2 | |
| 耐震动 | | IEC61131-2 规定连续震动 5 Hz ~ 8.3 Hz 3.5 mm, 8.3 Hz ~ 150 Hz 1G | |
| 耐冲击 | | IEC60068-2-27 规定耐冲击 11 ms, 15G Peak, X, Y, Z 方向各 6 次 | |
| 尺寸 (W) x (H) x (D) mm | | 215 x 161 x 50 | |
| 开孔尺寸 (W) x (H) mm | | 196.9 x 142.9 | |
| 重量 | | 约 970 g | |

- 注:
- 背光模块半衰期的定义: 最大驱动电流下, 背光亮度衰退到最大亮度的一半时, 即为半衰期。所标示的寿命时间为 25°C 常温常湿工作环境下的预估值。
 - 隔离电路耐受规格: 可承受 1 分钟 1500 V 高压突波。
 - 消耗功率为无外接周边设备时, 人机本体所消耗的功率。建议选用的电源供应器容量为标示消耗功率的 1.5 ~ 2 倍, 以确保人机工作正常。
 - 建议使用隔离式电源供应器。
 - DOP-100 系列编辑软体 DOPSoft 系列及其使用操作手册, 可由台达网站下载取得, 网址为 <http://www.delta.com.tw/ia>。
 - DOP-100 系列适用于工业自动化设备, 请仔细阅读此说明, 并依指示安装避免产生危险。

| 部件名称 Part Name | 有毒物质 -Hazardous Substances | | | | | |
|--|----------------------------|-------|-------|----------------|---------------|-----------------|
| | 铅(Pb) | 汞(Hg) | 镉(Cd) | 六价铬 (Cr VI) | 多溴联苯 (PBB) | 多溴二苯醚 (PBDE) |
| 金属部件 Metal Part | X | O | O | O | O | O |
| 塑料部件 Plastic Part | O | O | O | O | O | O |
| 电子件 Electronic | X | O | O | O | O | O |
| 触点 Contacts | O | O | X | O | O | O |
| 线缆和线缆附件 Cable & Cabling accessories | X | O | O | O | O | O |
| 电池 Bttery | O | O | O | O | O | O |

本表格依据 SJ/T 11364 的规定编制。
O: 表示该有害物质在该部件所有均质材料中的含量均在 GB/T 26572 规定的限量要求以下。
X: 表示该有害物质至少在该部件的某一均质材料中的含量超出 GB/T 26572 规定的限量要求。



5014052100

This table is made according to SJ/T 11364.
O: Indicates that the concentration of hazardous substance in all of the homogeneous materials for this part is below the limit as stipulated in GB/T 26572.
X: Indicates that concentration of hazardous substance in at least one of the homogeneous materials used for this part is above the limit as stipulated in GB/T 26572.